

INSTALLATION INSTRUCTIONS

AUTO-KS / KSN / RKR AUTO ENTRYCONTROL™ REMOTE KEYSWITCH

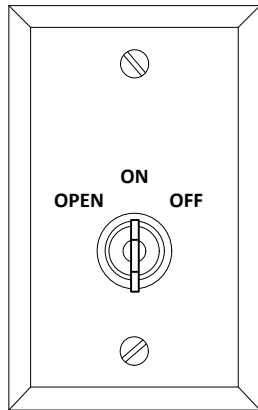

AUTO-KS
(Single-gang mount)

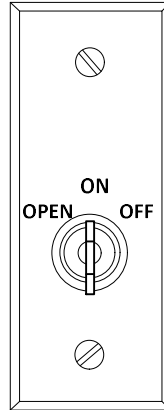

AUTO-KSN
(Mullion mount)

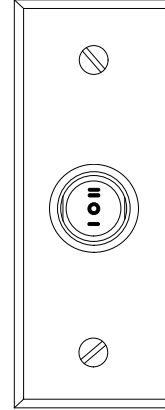

AUTO-RKR
(Mullion mount)

Wiring Instructions for use with SDC Auto EntryControl™ Low-Energy Operator:

STEP 1. Verify that the auto operator is powered OFF. Remove the housing cover & locate the OFF/ON/HOLD Switch on the end of the operator housing. The other end of the existing switch cable will already be connected to the I/O board.



OFF/ON/HOLD
Switch



I/O Board

STEP 2. Cut the cable within a few inches of the existing toggle switch. Take the cable coming from the I/O board, and carefully strip back 1 to 2 inches from the cable's outer jacket.

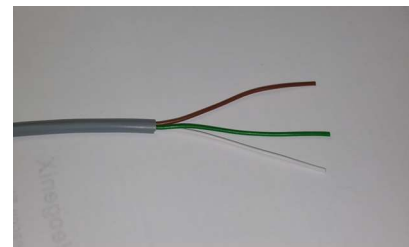

STEP 3. Run field wiring (22 AWG/3 Cond minimum) from the remote switch to the operator housing.
IMPORTANT: Keep all low voltage wiring separate from incoming High Voltage wiring.

STEP 4. Connect field wiring as shown for the appropriate model:

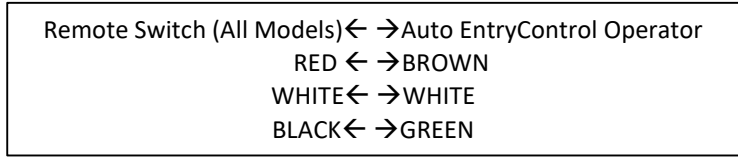

AUTO-KS/KSN

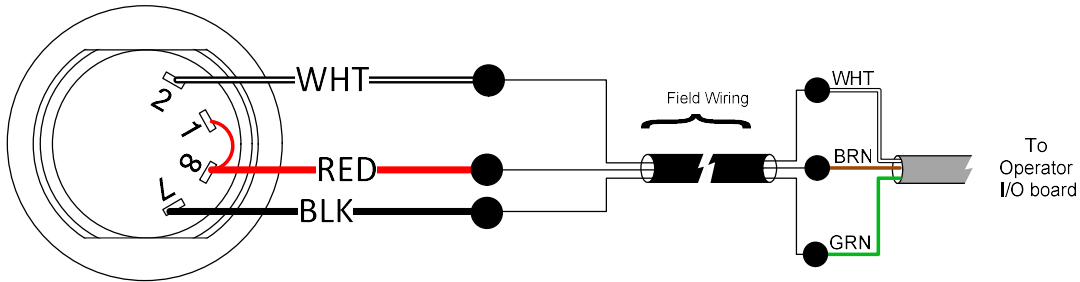

AUTO-RKR

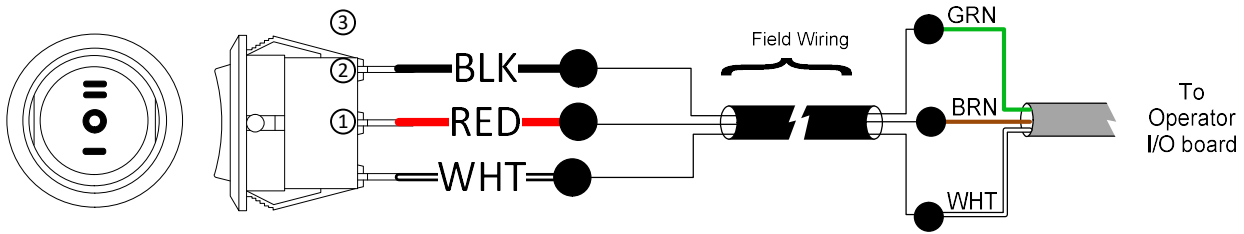

STEP 5. Power ON the operator and verify operation of the switch. The key will be removable from any of the available positions.

Rocker Position	Keyswitch Position	AutoEntryControl Operation	Switch Configuration
I	OPEN	Door Held OPEN	Red & Black are shorted
II	OFF	Operator OFF	Red & White are shorted
O	ON	Operator ON	

**AUTO-KSN (Narrow Keyswitch)
FRAME PREPARATION**

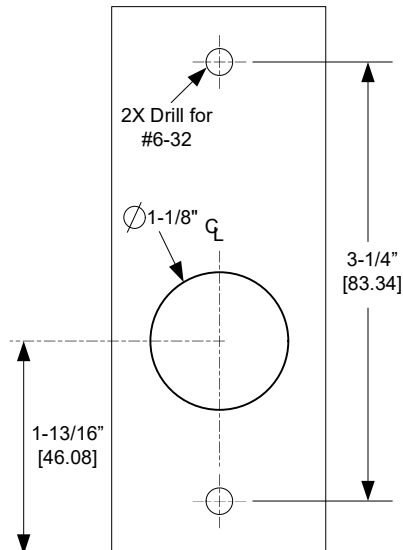

**AUTO-RKR (Rocker Switch)
FRAME PREPARATION**

