

SDC Security Door Controls

801 Avenida Acaso, Camarillo, Ca. 93012 • (805) 494-0622 •
www.sdcsecurity.com • E-mail: service@sdsecurity.com

INSTALLATION INSTRUCTIONS 410/420 SERIES PUSH SWITCH

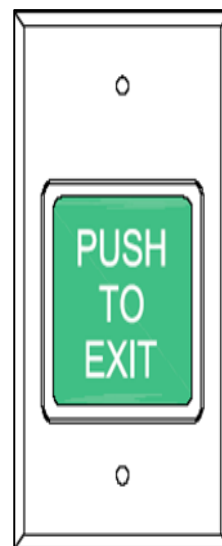

Electrical Specifications

Contact Type: SPDT (Form C)
Contact Ratings: 30VDC @ 5 AMPS
(Resistive)

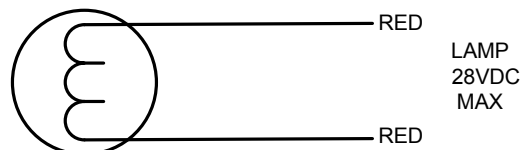
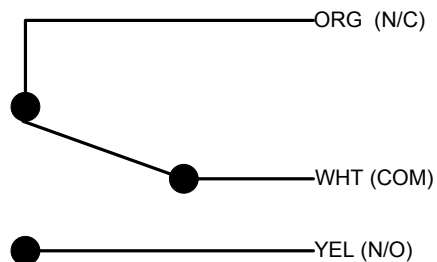

Any suggestions or comments to this instruction or product are welcome. Please contact us through our website or email engineer@sdsecurity.com

SDC SECURITY DOOR CONTROLS

3580 Willow Lane, Westlake Village, CA 91361-4921 • (805) 494-0622 • Fax: (805) 494-8861
 www.sdcsecurity.com • E-mail: service@sdsecurity.com

INSTALLATION INSTRUCTIONS MODEL 422 PUSH SWITCH



422GPE



422NGPE

Electrical Specifications

Contact Type: SPDT (Form C)
 Contact Ratings: 30VDC @ 5 AMPS
 (Resistive)

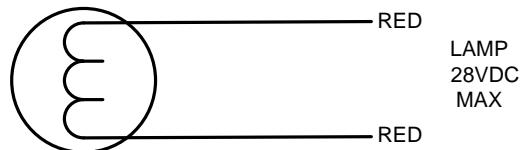
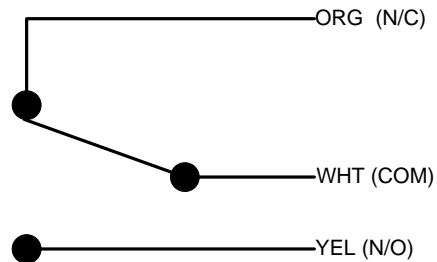

SDC SECURITY DOOR CONTROLS

3580 Willow Lane, Westlake Village, CA 91361-4921 • (805) 494-0622 • Fax: (805) 494-8861
 www.sdcsecurity.com • E-mail: service@sdsecurity.com

INSTALLATION INSTRUCTIONS MODEL 413NU & 423U PUSH SWITCH 1-60 SECOND ADJUSTABLE TIME DELAY

When the button is pressed, the lock releases for 1-60 seconds. If pressed again during the lock release period, the unit will "Retrigger" starting a new release period.

Electrical Specifications

Input Voltage: 12/24VDC
 Timer Current Draw: 20 ma
 Lamp Voltage: 28V @ 35ma
 Output Relay: SPDT
 Max Output Load: 30VDC @ 2 AMP

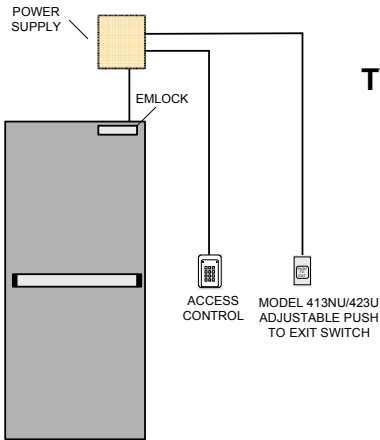
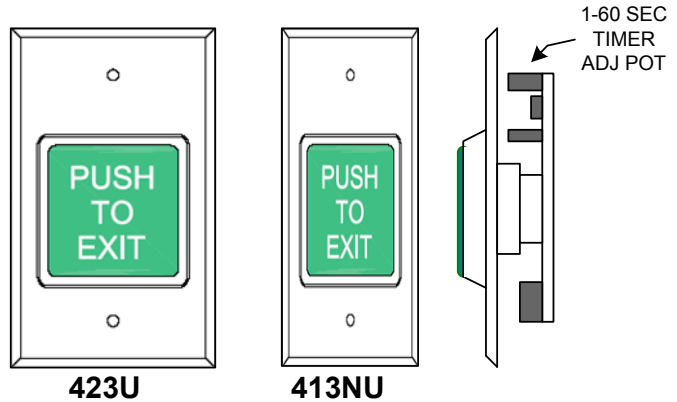

TYPICAL WIRING

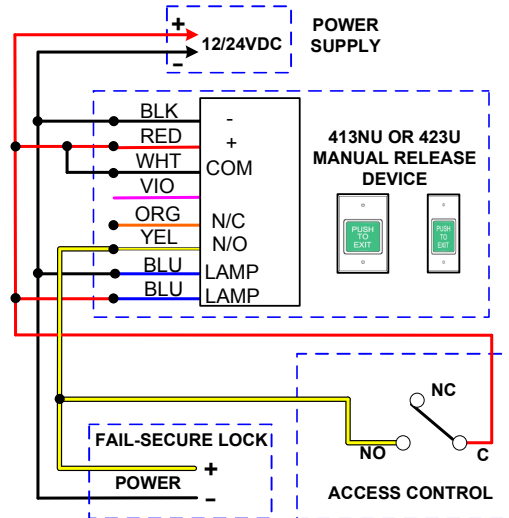
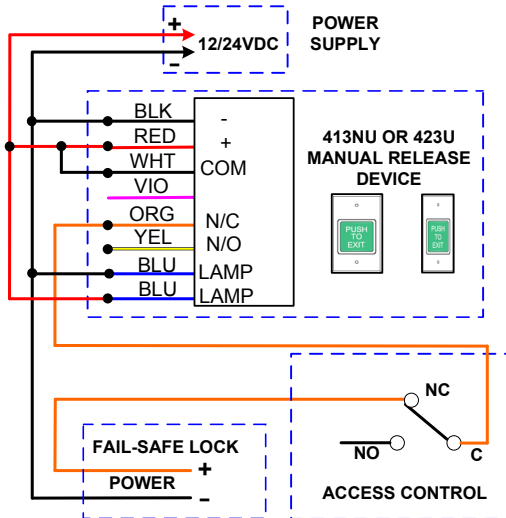
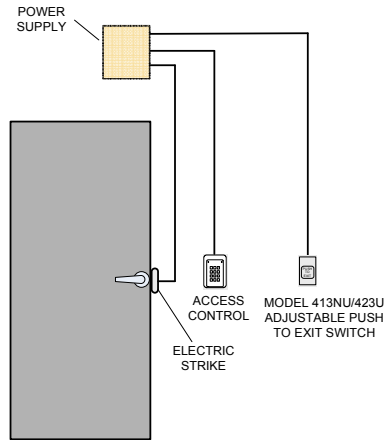

Any suggestions or comments to this instruction or product are welcome. Please contact us through our website or email engineer@sdsecurity.com

SDC Security Door Controls

801 Avenida Acaso, Camarillo, Ca. 93012 • (805) 494-0622 •
 www.sdcsecurity.com • E-mail: service@sdsecurity.com

INSTALLATION INSTRUCTIONS 414 & 424 PUSH SWITCH

424U



414NU

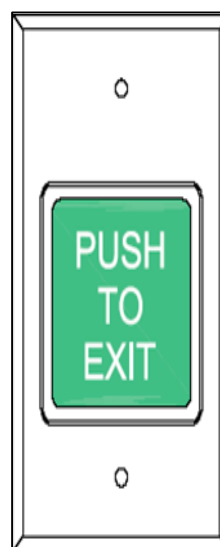

Electrical Specifications

Contact Type: DPDT (Form C)
 Contact Ratings: 30VDC @ 5 AMPS
 (Resistive)

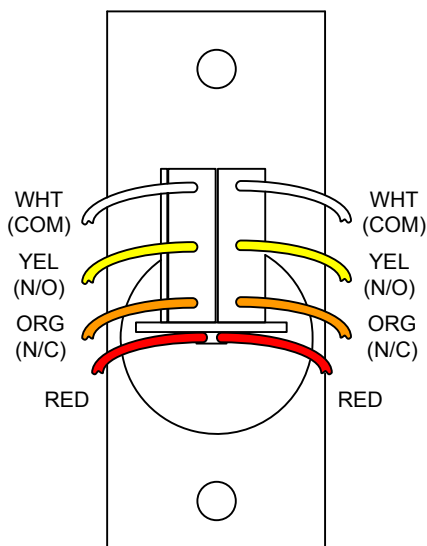
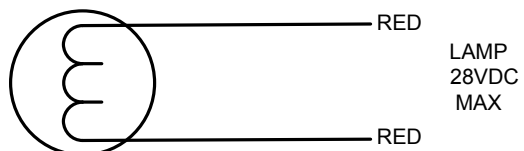

Any suggestions or comments to this instruction or product are welcome. Please contact us through our website or email engineer@sdsecurity.com

INSTALLATION INSTRUCTIONS MODEL 415N & 425 ON/OFF PUSH SWITCH

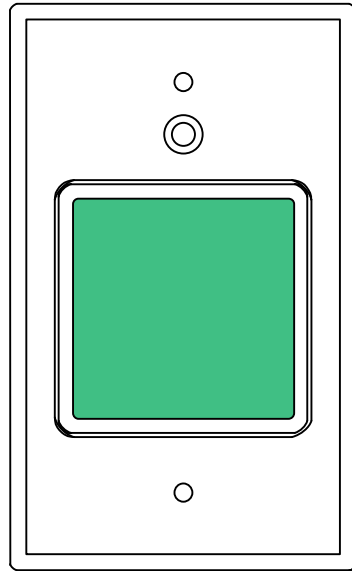

425

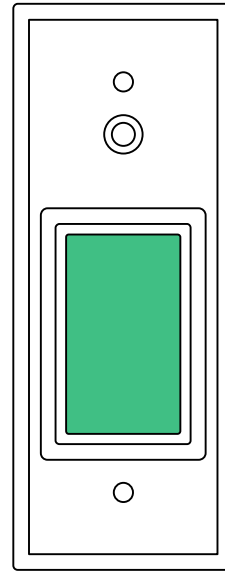

415N

Electrical Specifications

Contact Type: DPDT (Form C)
 Contact Ratings: 30VDC @ 5 AMPS
 (Resistive)

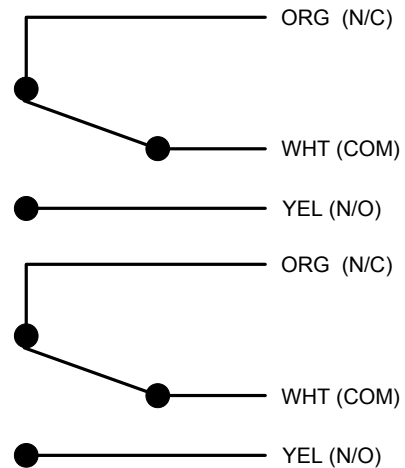
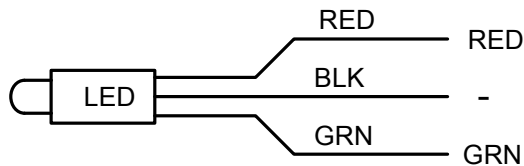

SDC Security Door Controls

3580 Willow Lane, Westlake Village, CA 91361-4921 • (805) 494-0622 • Fax: (805) 494-8861
 www.sdcsecurity.com • E-mail: service@sdsecurity.com

INSTALLATION INSTRUCTIONS MODEL 460 REQUEST – TO – EXIT - SWITCH

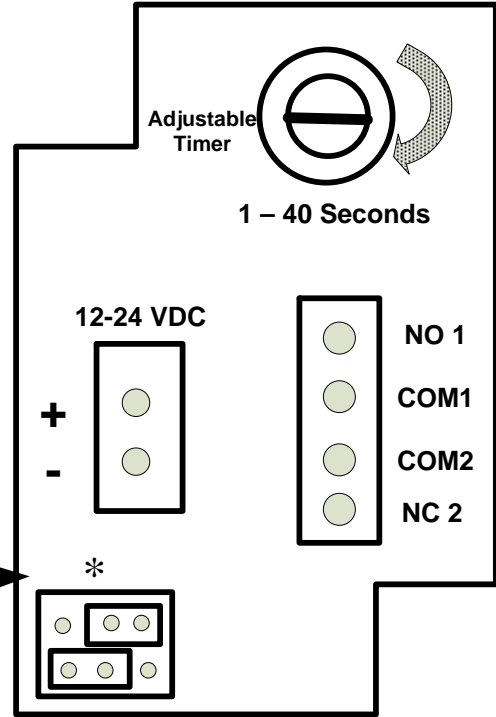
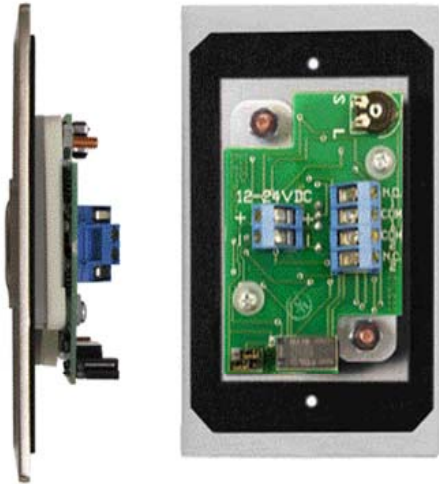

With the jumpers * as shown the red LED's are on in stand-by and the green LED's turn on when the relay is on.

Specifications

Input Voltage: 12/24VDC

Current:

LED On: Idle-60mA, Active 120mA
 LED Off: Idle-10mA, Active-60mA

Outputs:

1 N.O., 1 N.C., 2 Amp @ 30VDC

Switch Operating Environment

-40° F to +160°F (-40° C to +70°C)

Dimensions

4.5" H x 2.75" W x 1.25" D
 (11.4 x 7 x 3.2 cm)

Selectable Bi-color Illumination Status
 Relay Off – Red, Green or None
 Relay On – Red, Green or None

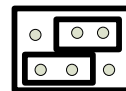

**Red On – Standby
 Green On – Relay Action**

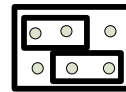

**Red On – Relay Active
 Green On - Standby**

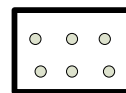

**Red Off
 Green Off**