

# 1190 / 2090 Spacesaver® Bolt Locks



The **Spacesaver®**, first designed and patented by SDC, is a fundamental innovation in electric locking technology for access control applications. The stainless steel bolt projects at right angles to the lock mechanism, allowing installation of Spacesaver® locks, by means of a simple cutout, in virtually any standard 1.75" frame, or in most door lock stiles. With the entire lock concealed, esthetic acceptability is complete, security is greater and installation in old or new construction is fast, easy and economical.

## FEATURES

### POWERFUL EXTRA HEAVY DUTY DESIGN

The **1190** and **2090** Spacesaver® bolt locks are the most powerful commercial grade units available on the market. They are designed to provide years of trouble free operation. There are only three moving parts within the hefty solid metal body of the **1190A** and five in the **2090A**.

### POWERFUL EXTRA HEAVY DUTY SOLENOID

The solenoids are the strongest found in the industry for commercial or industrial grade applications. The power and strength of the solenoids far surpasses any competitive models. All Spacesaver® lock solenoids are manufactured by SDC to precision specifications. SDC solenoids are capable of superior overall performance in both force and longevity, providing years of service.

### CODE COMPLIANCE

Classified in accordance with Uniform Building Code standard 7-2, "Fire Test for Door Assemblies"

### SOLID STAINLESS STEEL BOLT

Greater security is provided by the 0.75" (19 mm) diameter solid stainless steel bolt. The bolt rotates freely, making attempts to tamper or cut extremely difficult.

### FIELD ADJUSTABLE AUTO-RELOCK SWITCH

The automatic relock switch keeps the bolt retracted while the door is open. The door depresses the ball switch assembly on closure, causing the bolt to project automatically, locking the door. In addition, the ball switch assembly is bidirectional, permitting the locks to be used on swinging and sliding doors.

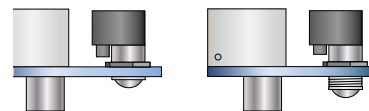





Fig. 1

Fig. 2

The auto relock assembly is field adjustable to compensate for wide door gap. See Figure 1 & 2

MODELS	
 <b>1190AU</b>	Fail-safe, 24VDC only
 <b>1190AWD</b>	Fail-safe, 24VDC only, specifically for wood frames
 <b>2090AU</b>	Fail-secure, 24VDC only





## LOCK FUNCTION

### 1190A FAILSAFE

The 1190A is locked when energized. Recommended for safety applications, it is intended that the door unlock automatically when power is interrupted by the access control, power failure or signal from a fire life safety system.

- Bolt Throw 0.75"

### 2090A FAILSECURE

The 2090A is locked when de-energized and unlocked when energized. Recommended for security applications only, it is intended that the door automatically locks when power is interrupted by the access control or power failure.

- Bolt Throw 0.75"
- Auxiliary Locks
- Complies with "Positive Pressure" Requirements of Standard UL10C
- Listed US & Canada
- Bolt Throw 0.75"

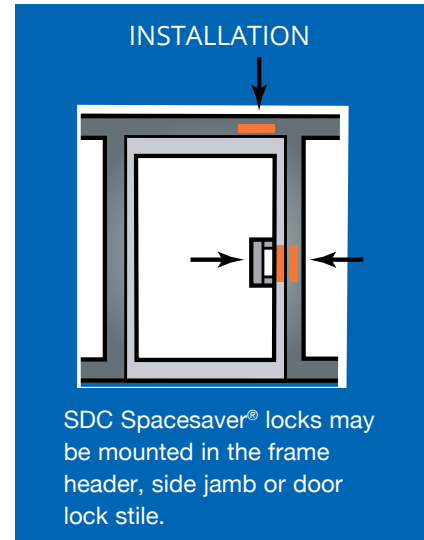

Figure 3A, 3B, 3C, 3D: Typical Frame Header or Side Jamb Installation

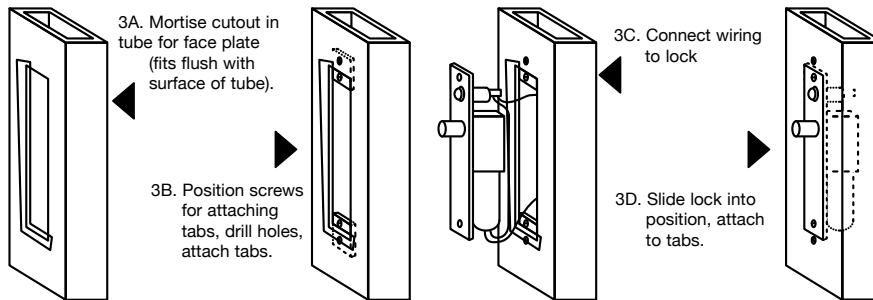
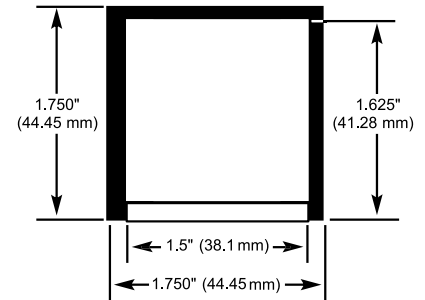

Figure 4



## SPECIFICATIONS

<b>Face Plate</b>	8"H x 1-1/2"W x 1/8"D - standard 11"H x 1-3/4"W x 1/8"D - wood
<b>Strike</b>	4"H x 1-1/2"W x 1/8"D
<b>Frame Inner Dimension Requirements</b>	<b>1190A:</b> 8"H x 1-1/2"W x 1-1/2"D (See figure 4) <b>2090A:</b> 10"H x 1-1/2"W x 1-1/2"D
<b>Bolt Material</b>	Solid Stainless Steel
<b>Bolt Diameter</b>	3/4"
<b>Bolt Throw</b>	3/4"
<b>Mounting Tabs</b>	Two aluminum mounting tabs are provided for easy lock installation. See figure 3B <b>1190A:</b> 0.7 Amp @ 24VDC <b>2090A:</b> Inrush 2.5 Amp, Continuous 0.5 Amp @ 24VDC

PRODUCT SKU SAMPLE: **1190AU D**



## HOW TO ORDER

### 1| SPECIFY MODEL

- 1190AU** Failsafe, 24VDC only
- 1190AWD** Failsafe, 24VDC only, specifically for wood frames
- 2090AU** Failsecure, 24VDC only

### 2| SPECIFY OPTION

- B** Bolt Position Sensor, SPDT
- D** Door Position Sensor, SPDT

