

1581S Delayed Egress Mini Exit Check®

When unauthorized egress is initiated, the Mini Exit Check® delays egress through the door for 15 seconds. Meanwhile, the person exiting must wait while personnel or security respond. The door unlocks after 15 seconds have elapsed, permitting egress. A signal from the fire/life safety system will release the lock for uninhibited egress in an emergency.

**PUSH UNTIL ALARM
SOUNDS. DOOR CAN BE
OPENED IN 15 SECONDS.**



EXIT CHECK® APPLICATIONS INCLUDE:

Restricting the egress of patients for their own safety. Restricting the egress of commercial center patrons for minimum security application needs.

SIZE MATTERS

The Mini Exit Check® is designed to meet the needs of long term care and commercial facilities that require a smaller, less obtrusive, and less expensive delayed egress lock that is better suited for minimum security needs.

In addition, the subdued alarm tone is less disruptive to patients and staff. SDC has also maintained all the features and status outputs found in most higher holding force delayed egress locks on the market.

FEATURES

- 650 lbs Holding Force
- Subdued alarm with 2 distinct tones:
Alarm activation - intermittent, Door release - continuous
- Choice of activation trigger:
Door movement
Latching exit device with switch kit
Non-latching REX bar
- Self-aligning and vandal resistant proximity sensor trigger
- DIP Switch selectable Door Prop activation feature
- DIP Switch selectable REX on Reset input. Allows single input from Keypad or Card Reader to REX and Reset the 1581S
- 5 foot cable

ACCESS CONTROL

Access controls may be utilized for authorized egress or access. Access from the exterior of latching doors requires an additional means of mechanical lock release, such as a mechanical key or electric strike.

LOCAL APPROVAL

All installations must be approved by the Authority Having Jurisdiction (AHJ).

MODEL

1581S Single Mini Delayed Egress Lock, 650 lbs holding force.
Specify 2 for pair of doors

SPECIFICATIONS

Voltage	Auto sensing 12/24 VDC input
Current	500mA @ 12VDC 320mA @ 24VDC
Size	10"L x 2"H x 2-3/8"D
Inputs / Outputs	Sustained bypass input Access control / REX input, timed Door secure / unlocked output Alarm activation output Door Position Status (optional) Magnetic Bond Sensor (optional)
Weight	7.0 lbs



EXTENDED FEATURES

SLAVE LOCK OUTPUT

The slave lock output enables the use of two units for pairs of doors and ensures that pushing on one door leaf will cause both doors to release.

ACTIVATION TRIGGERS

The Exit Check® is equipped with a built-in activation trigger and a remote trigger device input.

BUILT-IN ACTIVATION TRIGGER

The built-in activation trigger may only be used with doors equipped with a latch assembly (i.e. exit device or mechanical lockset).

The mechanical latch mechanism must be locked on the exterior and unlocked on the interior. From the inside, retracting the door latch and applying pressure causes limited door movement. The built-in activation trigger senses the door movement and initiates delayed egress operation.

Remote Activation Trigger Input

Activation Trigger For Non-Latching Doors

The remote trigger activation input must be used with doors without latch assemblies (i.e. latchless glass and herculite doors).

Activation may be triggered by the SDC **MSB550** Switch Bar or the SDC **PSB560** Sure Exit®, request-to-exit push bar. A power transfer device is required.

Pushing on the request-to-exit push bar immediately activates the delayed egress operation.

Activation Trigger For Latching Doors

Where preferred, activation may be accomplished by a latch monitoring strike, or a switch installed in a standard latching exit device or lockset. A power transfer device is required for exit devices equipped with a trigger switch.

COMPONENT CONSIDERATIONS

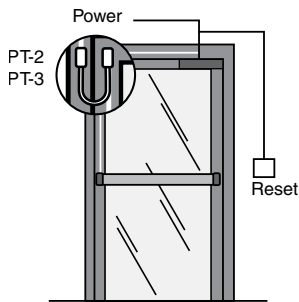

Sense Bar Trigger Non-Latching
PSB560, MSB550

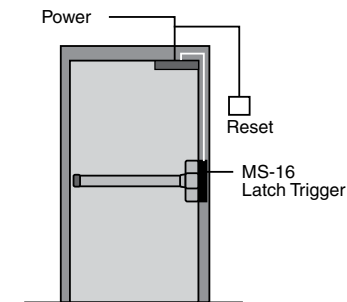

Latch Monitoring Strike Trigger
For Mortise Exit Devices

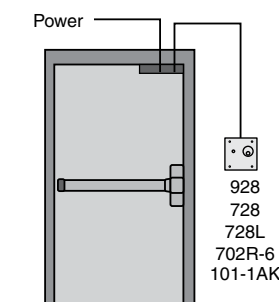

Wall Mount Reset Station
Required with 1581SND

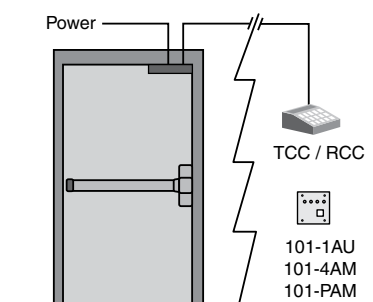

Remote Annunciators
and Control Panels

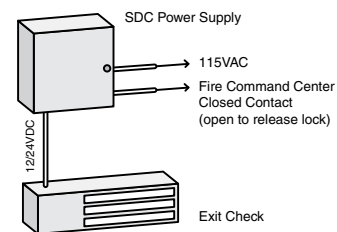

600 SERIES POWER SUPPLY
EMERGENCY RELEASE

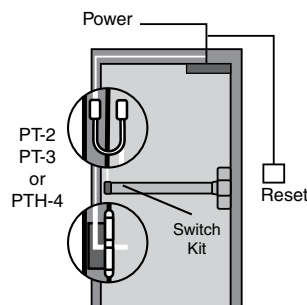

Latching Exit Device with
Built-in Switch Kit Trigger

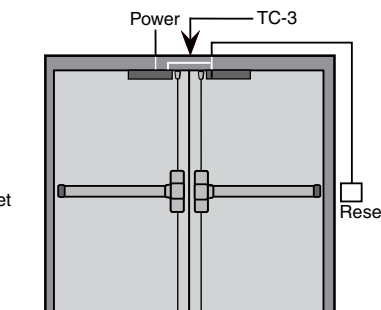

Pair of doors with two locks and required
TC-3 cable for power and slave operation
Pushing either door triggers
the delayed release of both doors.

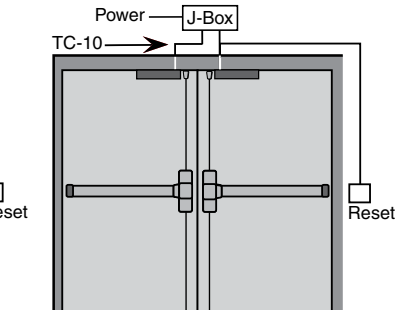

Pair of doors with two locks and required
TC-10 cable for power and slave operation
Pushing either door triggers
the delayed release of both doors.

HOW TO ORDER

1 | SPECIFY MODEL

1581S Mini Delayed Egress Exit Check®

2 | SPECIFY OPERATION MODE

- ND** UBC, California Building Code, OSHPD, NFPA 101, IBC & IFC Compliant
15 second fixed exit delay, 2 second nuisance delay.
Field selectable manual power up after emergency release for California and OSHPD compliance
- NH** IBC, IFC, NFPA 101 Compliant
30 second fixed exit delay, 2 second nuisance delay
- NC** CBC Compliant
15 second fixed exit delay, 2 second nuisance delay, power up unlocked fixed
- BD** BOCA National Building Code Compliant
15 second fixed exit delay, 1 second nuisance delay, auto reset 30 seconds after door closure
- BH** BOCA National Building Code Compliant
30 second fixed exit delay, 1 second nuisance delay, auto reset 30 second after door closure
- BC** BOCA National Building and Chicago Complaint
15 second fixed exit delay, 0 second nuisance delay, auto reset 30 second after door closure

3 | SPECIFY FINISH

Anodized Finishes

- V** Aluminum (standard)
- Y** Black anodized

Painted Finishes

- C** Bright Brass powder coat
- D** Dull Brass powder coat
- X** Dark bronze powder coat

Plated Finishes (special order)

- P** Bright chrome
- Q** Dull chrome

4 | SPECIFY STATUS OUTPUTS (OPTIONAL)

- D** Door position status, SPDT
- B** Magnetic bond sensor, SPDT

5 | SPECIFY RESET AND CONTROL DEVICE

Select Reset Station for NC, NH and ND functions

- 918** EntryCheck Digital Keypad, 500 user codes - Keyless Reset - manual power up - bypass
- 728** Key Switch, 2 keys, 1 gang - Reset - manual power up - sustained bypass
- 728L3** Key Switch, 2 keys, 1 gang, LED status indicator - Reset - manual power up - sustained bypass
- 702R** Separate wall mount reset key switch assembly, MO SPDT dry contact, 6 amp @ 30VDC max., accepts standard 1-1/8" to 1-1/4" (Mortise key cylinder not included)
- 101-1AR** Key switch assembly, 2 gang, LED status indicator, less cylinder - Reset - manual power up - sustained bypass
- 101-4AM** Four station remote annunciator

ACCESSORIES

Required when using two locks on a pair of doors, cables enable slave operation. Pushing either door triggers the delayed release of both doors.

- 1581S-TC3** Cable kit for connecting two locks through the frame header
- 1581S-TC-10** Cable kit for connecting wiring for two locks in a remote junction box

REMOTE WALL MOUNT ANNUNCIATORS

Wall mount annunciators identify unauthorized egress at remote locations such as nurses stations, enabling quick personnel response.

101-1A Remote or local single door annunciator with audible alarm and tri-color LED, 1 Gang
 Green - Secure
 Amber - Egress initiated
 Red - Door unlocked



101-4AM Remote four door annunciator with audible alarm mute button. Four tri-color LEDs, 2 Gang
 Green - Secure
 Amber - Egress initiated
 Red - Door unlocked



101-PAM Remote single door annunciator with 3 push button switches for momentary access. On/off and audible alarm mute button with tri-color LED, 2 Gang: *Recommended for remote installation only*
 Green - Secure
 Amber - Egress initiated
 Red - Door unlocked



POWER SUPPLIES

Delayed egress applications require properly approved power supplies with emergency release capability.

621B Power supply module, 1 Amp 12/24VDC, Class 2 40VA, 24VAC transformer required to achieve 1 Amp output. See SDC TP2440 plug-in or TJ2440 base mount transformers

621P Power supply module, 1 Amp, 12/24VDC, Class 2, with UL Listed plug-in transformer.

621PJ Power supply module, 1 Amp, 12/24VDC, Class 2 and small enclosure with cover mounted LED power supply status indicator and UL Listed plug-in transformer.

602RF 1 Amp class 2 output (4 outputs optional.)

631RF 1.5 Amp class 2 output (4 & 8 outputs optional.)

632RF 2 Amp class 2 output, (4, 8 & 12 outputs optional.)

634RF 4 Amp; Field select one 4 Amp output or two 2 Amp class 2 outputs (4, 8, 12 & 16 outputs optional.)

636RF 6 Amp; Field select one 6 Amp output or three 2 Amp class 2 outputs (4, 8, 12, 16, 20 & 24 outputs optional)

EMERGENCY RELEASE

600 Series Power Supply Emergency Release

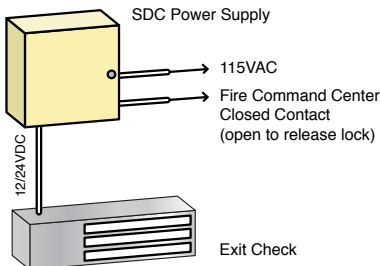

SURE EXIT® REQUEST-TO-EXIT SENSE BAR

The Sure Exit® is a non-latching, heavy duty request-to-exit push bar that will activate the Exit Check when slight pressure is applied to the bar



- PSB560V** Aluminum Anodized
- PSB560Y** Black Anodized
- PSB560S** Bright Stainless Steel
- PSB560U** Brushed Stainless Steel

Stainless steel and brass optional. 36" is standard. For wider doors specify 42" or 48". May be field cut.

Actuation	Actuation: Pressure Sense
Technology	Tri-Failsafe
Voltage	12/24VDC Voltage Sense Input
Current	20 mA at Rest, 115 mA Active
Lock Output	SPDT, 3 Amp @ 30VDC
Alarm Shunt/Status Output	SPDT, 3 Amp @ 30VDC

REQUEST-TO-EXIT SWITCH BAR

The MSB550 is a non-latching, heavy duty request-to-exit push bar that will activate the Exit Check when slight pressure is applied to the bar



- MSB550V** 628 Aluminum Anodized
- MSB550Y** 335 Black Anodized
- MSB550S** 629 Bright Stainless Steel
- MSB550U** 630 Brushed Stainless Steel

Stainless steel and brass optional. 36" is standard. For wider doors specify 42" or 48". May be field cut.

Contact	SPDT Dry, 3 Amp @ 28VDC Two contacts optional
----------------	---

EXIT DEVICE SWITCH KITS



Recommended for retrofit applications, switch kits are field installed in the inactive hinge pad of rim mount exit devices, mortise exit devices, concealed vertical rod exit devices and surface vertical rod exit devices.

Make and Model to be fitted

- 00510** Von Duprin 33, 35, 98, 99
- 00510-2** Von Duprin 33, 35, 98, 99 DPDT
- 00511** Von Duprin 55
- 00512** Von Duprin 88
- 00514** Dor-O-Matic 990, 1090, 1990, 2090
- 00516** Sargent 9600, 9700, 9800, 9900
- 00517** Adams Rite 8300, 8400, 8700, 8800
- 00518** Precision Apex Series 1100
- 00518A** Percision Apex Series 2100 - 2800
- 00519** Jackson 1095
- 00519-2** Jackson 1095 DPDT
- 00521** Corbin 7000
- 00525** Monarch 18 and 19
- 00527** Sargent 80
- 00527-2** Sargent 80 DPDT
- 00528** Sargent 20/60
- 00531** Yale 7000 (Dogging mechanism required) & Corbin 4000
- 00535** Kawneer Mid Panel Line Dor-O-Matic 1390
- 00540** Arrow 53/5400 series