

DISABILITY SOLUTIONS



Electrified Hardware for Compliance

the lock behind the system

SDC
Security Door Controls

TABLE OF CONTENTS

INTRODUCTION	3
ADA COMPLIANCE	3
LOW ENERGY COMPLIANCE	4
LOW ENERGY OPERATORS	
AUTO Series Low Energy Swing Door Operators	6
PUSH PLATES & PANELS	
480 Series Narrow, Square and Round Push Plates	9
480V Series Vestibule Push Plates	11
480AA Series Push Panels	11
BOLLARDS	
BP Series Square Bollard Posts	12
CBC Series Square High-Low CBC Compliant Bollard Posts	12
COMPONENT CONSIDERATIONS	
Hands Free Door Solution™	13
COMMON ADA COMPLIANT APPLICATION SOLUTIONS	
Automated Lock Access Control	14
Automated Electric Strike Access Control	14
Automated Mortise Lock Access Control	15
Hands Free ADA Compliant Access Control	15
Automated Entrance IP-Based Access Control	15
Healthcare Market Automated ADA Compliant Openings	15
ADA COMPLIANCE REFERENCES	
ADA Inspections Checklist	16
ANSI/BHMA A156.19-2019 Standard for Power Assist and Low Energy Power Operated Swinging Doors	16
ANSI/BHMA A156.19-2019 Hardware Highlights	17
COMPLETE COMPONENT CONSIDERATIONS	18

INTRODUCTION

SDC's line of ADA Controls are designed to maximize public door accessibility for the Americans with Disabilities Act (ADA) Title III applications. Our product focus is on the section of the law - Title III - that addresses Public Accommodations and is intended to guarantee equality for those who are physically handicapped or disabled. Included are low energy swing door operators, push plates, actuators and touch panels, and bollard posts. They all provide our latest and most convenient features to provide safe access for ADA applications and code compliance.

ADA COMPLIANCE

ADA is a civil rights law that is intended to guarantee equality for those who are physically handicapped or disabled. There are four major sections of the bill and they are intended to prohibit discrimination in employment, public service, public accommodations, and telecommunications.

SDC's focus is on Title III (Public Accommodations). Title III is not a product specification or a building code, but a directive to ensure equality in accessibility within public buildings. Such things as door opening size, door opening force requirements, door closing time, degree of door opening, and door and lock handle designs must all be addressed to satisfy the ADA guidelines.



For a complete listing of applicable ADA requirements and guidelines governing our products, please refer to ADA compliance reference starting on page 16.

LOW ENERGY CODE COMPLIANCE

The Americans with Disability Act (ADA) has required many businesses to install automatic doors to become ADA-compliant. One of the intents of this law is to ensure that handicapped people are able to access or egress a building with little exertion, despite their physical disability. The elderly also benefit from the law, as many cannot easily open manual doors on their own, whether disabled or not. The two prevalent accessibility standards in the United States are ICC A117.1 – Accessible and Usable Buildings and Facilities and the 2010 ADA Standards for Accessible Design.

Automatic doors hold an outstanding safety record in the US with over 50 billion safe automatic door openings and closings annually. Automatic doors and components



should be manufactured in compliance with the American National Standard for Power Operated Pedestrian Doors, ANSI A156.10, which governs and defines their installation, sensing devices and safety requirements. Many automatic doors are designed to integrate with a variety of electronic sensors, access control systems, electromagnetic locks, electric strikes and exit devices for security applications.

There are three basic types of automatic doors: swinging, sliding and folding doors. Automatic low-energy swinging doors are designed for applications requiring ADA compliance or user convenience. These doors are usually available in three configurations:

- A single door that swings in or out and is left-handed or right-handed – most common
- A pair of doors that simultaneously swing in the same direction
- Double egress – a pair of doors that simultaneously swing in opposite directions

Low-energy swinging doors are governed by ANSI 156.19 & ADA and include these features and requirements:

- “Knowing Act” activation (push button or push plate)
- Slow opening and closing speeds
- Full open time delay
- Low operating force
- Floor space requirements
- Signage
- Additional Considerations

ACTIVATED BY A KNOWING ACT

Knowing Act – Consciously initiating the powered opening of a low-energy door using acceptable methods including: wall or jamb-mounted contact switched such as push plates; fixed non-contact switches; the action of manual opening (pushing or pulling) a door; and controlled access devices such as keypads, card readers, and key switches.



Per ANSI, generally should be located:

- A maximum distance of 12ft from the center of the door, preferably 1-5ft for 5 second hold open time
- At a height between 34in. (min) and 48 in (max)

OPENING/CLOSING SPEED

Doors shall open from closed to back check, or 80° whichever occurs first, in 3 seconds or longer.

Door shall close from 90° to 10° in 3 seconds or longer. Doors shall close from 10° to fully closed in not less than 1.5 seconds.

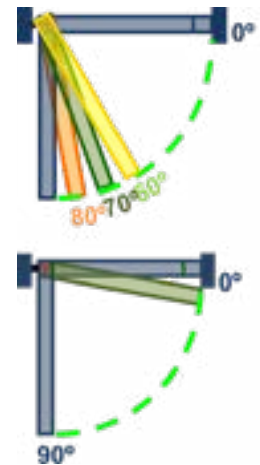

LOW ENERGY CODE COMPLIANCE

HOLD OPEN TIME DELAY

When powered open, the door shall remain at the fully open position for not less than 5 seconds.

Exception: When push-pull activation is used, the door shall remain at the fully open for not less than 3 seconds.

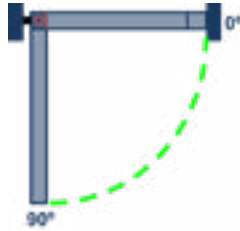

SIGNAGE

Doors shall be equipped with signage visible from either side of the door, instructing the user as to the operation and function of the door. The signs shall be mounted 50" +/- 12" from the floor to the center line of the sign. The letters shall be 5/8" high minimum.

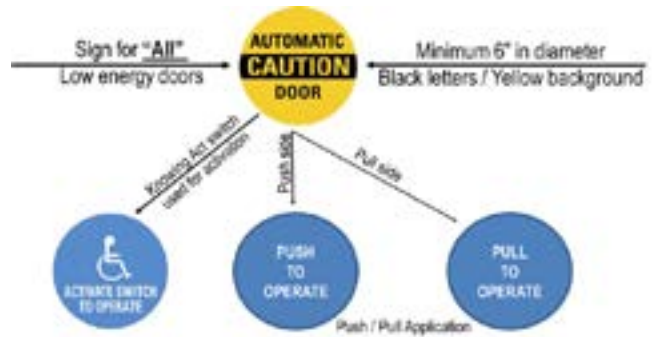

LOW OPERATING FORCE

The force required to prevent a stopped (obstructed) door from opening or closing shall not exceed 15lbf (pound-force) measured 1" from the latch edge of the door at any point during opening or closing.



ADDITIONAL CONSIDERATIONS

It is recommended that the low energy operator be inspected at the time of installation, and at minimum annually thereafter, by an American Association of Automatic Door Manufacturers (AAADM) certified inspector.

FLOOR SPACE REQUIREMENTS

Consult ICC/ANSI A117.1 Accessible and Usable Buildings and Facilities, and other building codes for additional information regarding accessibility requirements.

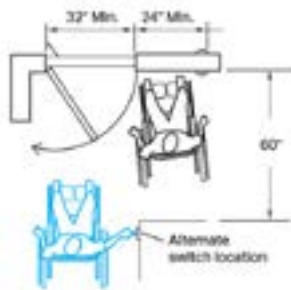

As you know building codes are always progressing and impact the application of access and egress solutions to doorways. Because the adoption and enforcement of building codes varies across the country - even with the existence of national Fire, Life Safety, ANSI and ADA standards - you should always consult the local Authority Having Jurisdiction (AHJ) for compliance requirements governing any application of ADA Compliant Solutions to a project.

LOW ENERGY OPERATORS

AUTO Series Low Energy Swing Door Operators



SDC's EntryControl™ AUTO series low energy swing door operators with built-in 1 amp+ power supply provide the ability to power motorized electric latch retraction without a separate power supply. Designed for low-power retrofits of any building entrance with an exit device, SDC operators feature fast, one-man installation time and help meet US and Canadian disability compliance for door installation in retail storefronts, office buildings, campuses and healthcare facilities. They provide user convenience and are easily configured for touchless door applications.



Built with a state-of-the-art microprocessor-based unit, SDC's operator is self-tuning and self-learning while offering non-handed operation, full mechanical stops and a variety of interface options for sensors, push-plates, fire alarms and electrified locks – making it easy to integrate with popular access and egress control hardware.

SDC's operator is belt driven with a combination of gears and pulleys which requires less torque, less power, absorbs more abuse, and is quieter than other automatic door openers while complying with all US and Canadian ADA requirements. Onboard diagnostics simplifies troubleshooting for ease of installation and all SDC operators can be easily configured for surface mounted push/pull applications. ANSI certification is not required for initial installation.

FEATURES AND BENEFITS

Easy, single technician installation

- Pre-dilled mounting holes
- Slotted back plate for easy mounting
- Fixed mounting bolt for hanging drive unit

Single button setup, self-tuning, self-learning

- Automatically adjusts torque for different door sizes/weights
- Calculates opening and closing force to meet ADA compliance
- Calculates door travel
- Memory is non-volatile

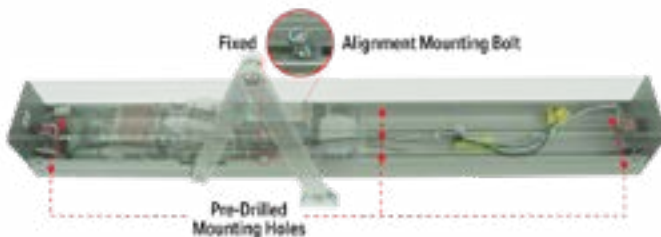

Built-in 1 amp+, 24 VDC power supply

- Powers and controls magnetic locks, electric strikes and motorized latch retraction

ADDITIONAL FEATURES INCLUDE

- Onboard lock sequencing
- Extremely quiet operation
- Momentary back pressure relief
- Obstruction detection
- Push and go activation option
- Hold-open timer
- Power close option
- External function switches
- Preset dip switches for alternative functions
- Push or pull compatible
- Spindles included
- Customizable programming for system design
- USB port to upload customized programming
- Non-handed
- High traffic use
- Two year warranty

LOW ENERGY OPERATORS

APPLICATIONS

HANDING DETAILS

One operator works for any hand of door.

The hand depends on how the operator is mounted to the header. Determine the hand of the door to be automated and mount the operator as shown below.

The removeability of the motor assembly makes installation and mounting easy.



PUSH/PULL CONFIGURATION

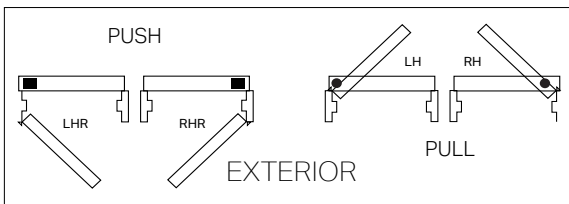

■ = I/O board towards hinge

● = Motor towards hinge

DOUBLE DOOR CONFIGURATION

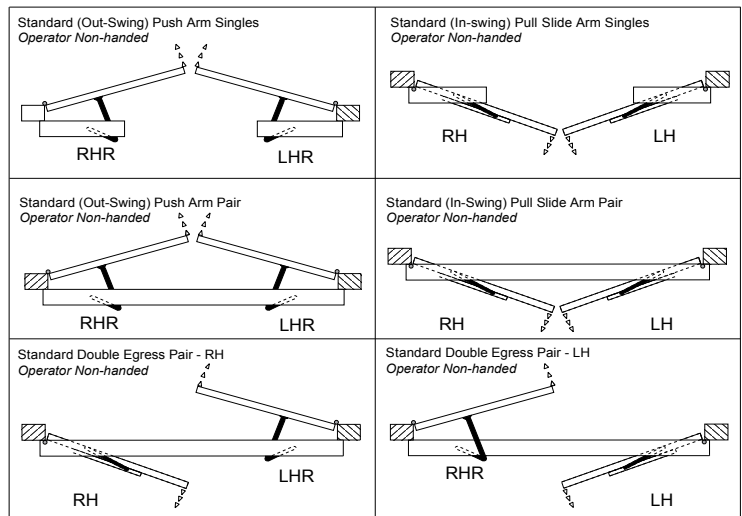

AUTOS1
Standard Arm - PUSH Side



AUTOS2
Track Arm - PULL Side

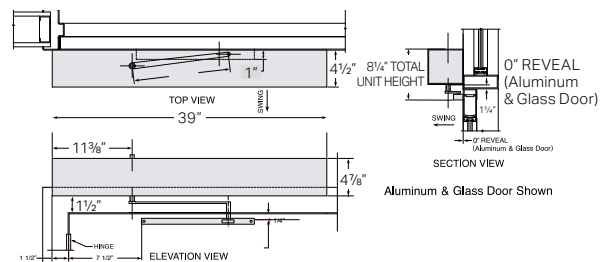
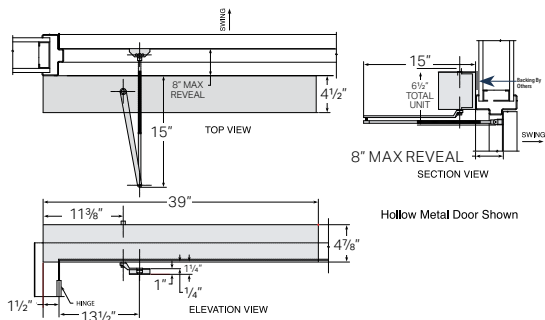

LOW ENERGY OPERATORS

ACCESSORIES

OPTIONAL ARM EXTENSIONS

AUTO-AEV Arm Extension for PUSH Arm, Reveal > 8" (13" Max), 628

AUTO-AEX Arm Extension for PUSH Arm, Reveal > 8" (13" Max), , 710

OPTIONAL SPINDLES

SP20 20mm Spindle

SP35 35mm Spindle

SP50 50mm Spindle

SP80 80mm Spindle



PRESENCE SENSOR AND DOOR RE-ACTIVATOR

The AUTO-IR allows re-activation of door before contact is made during the closing cycle, protecting slow-moving people as well as people trailing behind. It reliably detects stationary as well as moving objects in the swing path of an automatic door. When using the AUTO-IR mounted on the application side of the door, the need for an extended hold open time is eliminated, allowing the door to begin the close cycle after the minimum 5 second hold open time has elapsed. Following a door activation, the AUTO-IR remains enabled to allow continued automatic non-contact re-activation capability should someone remain in the door opening while the door is open or while it is closing

- 48", length field-adjustable
- Exceeds ANSI 156.19 standards - contactless experience
- Proven active infrared technology
- Guarantees smooth and safe operation of a door
- Sensor is only active following a knowing activation



AUTO-IR Presence Sensor and Door Re-Activator

REMOTE KEY LOCK AND ROCKER SWITCHES

The AUTO switches offer cost-effective, remote automatic door operator controls. Fully compatible with all SDC operators, they provide the same OFF-AUTO-HOLD OPEN functionality as the operator's built-in switch. All models include mounting hardware and termination wire leads. Key lock switch models are keyed alike and include two keys. Key is removable in all three positions.



AUTO-KS Single Gang Key Lock Switch

AUTO-KSN Narrow Key Lock Switch

AUTO-RKR Narrow Rocker Switch

HANDHELD PROGRAMMER MODULE FOR CUSTOM CONFIGURATION

Allows for custom configuration and adjustment of:

- All inputs and outputs
- Opening/closing and timer settings
- Advanced interlock/sequencing capabilities
- Diagnostic information



AUTO-PROG Handheld Programmer

PUSH PLATES AND PANELS

SDC's push plates and panels combined with SDC's operator, bollards and locking devices allow for complete access and egress solutions for ADA compliant applications. Included are round and square push plates, as well as wall mount and full size push panels. All types can be wireless or hardwired, bollard or wall mounted. Designed specifically for handicap access, automatic door activation and request-to-exit applications. Pressing any part of plate causes switch activation.

FEATURES AND BENEFITS

- Entire plate surface activates switch
- SPDT or DPDT
- Round or square
- Bold debossed sign legends
- Black or blue infill
- Wireless or hardwired
- Various plate sizes for any application
- Heavy 18 gauge stainless steel plates
- Weather resistant

WIRELESS TRANSMITTERS & RECEIVERS

400RC433 433MHz One Channel Receiver

400W1-433 433MHz Micro Transmitter



480 Series

Narrow, Square and Round Push Plates



NARROW MULLION

- 482O1U** PUSH TO OPEN, Black Infill, SPDT
- 482A1U** PUSH TO OPEN, ♿, Blue Infill, SPDT
- 482B1U** PUSH TO OPEN, ⚠️, Blue Infill, SPDT

SINGLE GANG

- 482O2U** PUSH TO OPEN, Black Infill, SPDT
- 482A2U** PUSH TO OPEN, ♿, Blue Infill, SPDT
- 484O2U** PUSH TO OPEN, Black Infill, DPDT
- 484A2U** PUSH TO OPEN, ♿, Blue Infill, DPDT

4½" SQUARE

- 482O4U** PUSH TO OPEN, Black Infill, SPDT
- 482A4U** PUSH TO OPEN, ♿, Blue Infill, SPDT
- 482B4U** PUSH TO OPEN, ⚠️, Blue Infill, SPDT
- 484O4U** PUSH TO OPEN, Black Infill, DPDT
- 484A4U** PUSH TO OPEN, ♿, Blue Infill, DPDT
- 484B4U** PUSH TO OPEN, ⚠️, Blue Infill, DPDT

4½" ROUND

- 482O4RU** PUSH TO OPEN, Black Infill, SPDT
- 482A4RU** PUSH TO OPEN, ♿, Blue Infill, SPDT
- 482B4RU** PUSH TO OPEN, ⚠️, Blue Infill, SPDT
- 484O4RU** PUSH TO OPEN, Black Infill, DPDT
- 484A4RU** PUSH TO OPEN, ♿, Blue Infill, DPDT
- 484B4RU** PUSH TO OPEN, ⚠️, Blue Infill, DPDT

6" SQUARE

- 482O6U** PUSH TO OPEN, Black Infill, SPDT
- 482A6U** PUSH TO OPEN, ♿, Blue Infill, SPDT
- 482B6U** PUSH TO OPEN, ⚠️, Blue Infill, SPDT
- 484O6U** PUSH TO OPEN, Black Infill, DPDT
- 484A6U** PUSH TO OPEN, ♿, Blue Infill, DPDT
- 484B6U** PUSH TO OPEN, ⚠️, Blue Infill, DPDT

6" ROUND

- 482O6RU** PUSH TO OPEN, Black Infill, SPDT
- 482A6RU** PUSH TO OPEN, ♿, Blue Infill, SPDT
- 482B6RU** PUSH TO OPEN, ⚠️, Blue Infill, SPDT
- 484O6RU** PUSH TO OPEN, Black Infill, DPDT
- 484A6RU** PUSH TO OPEN, ♿, Blue Infill, DPDT
- 484B6RU** PUSH TO OPEN, ⚠️, Blue Infill, DPDT

PUSH PLATES AND PANELS

MOUNTING ACCESSORIES



NARROW MULLION

400-1B Surface Box, 1 $\frac{3}{4}$ " x 4 $\frac{9}{16}$ " x 1 $\frac{3}{4}$ "

4 $\frac{1}{2}$ " SQUARE

480-4FB Flush Recessed Box, 6 $\frac{3}{4}$ " x 6 $\frac{3}{4}$ " x 2 $\frac{1}{8}$ "

480-4SB Surface Box, 5 $\frac{1}{2}$ " x 5 $\frac{1}{2}$ " x 2 $\frac{1}{8}$ "

480-4SBB Surface Box with Battery Compartment, 4 $\frac{1}{2}$ " x 4 $\frac{1}{2}$ " x 1 $\frac{3}{4}$ "

6" SQUARE

480-6SBB Surface Box with Battery Compartment, 4 $\frac{1}{2}$ " x 4 $\frac{1}{2}$ " x 1 $\frac{3}{4}$ "

SINGLE GANG

480-2SB Surface Box, 2 $\frac{3}{4}$ " x 4 $\frac{1}{2}$ " x 1 $\frac{5}{8}$ "

4 $\frac{1}{2}$ " ROUND

480-4RSB Surface Box, 5" x 2 $\frac{1}{8}$ "

480-4RG Gasket for 480-4RSB or 480-4RFB, 4"

480-4RFB Flush Recessed Escutcheon, 6 $\frac{3}{8}$ "

6" ROUND

480-6RSB Surface Box, 6 $\frac{7}{16}$ " x 2 $\frac{1}{8}$ "

480-6RG Gasket for 480-6RSB or 480-6RFB, 6"

480-6RFB Flush Recessed Escutcheon, 7 $\frac{3}{4}$ "

WIRELESS PUSH PLATE SWITCH KITS



482S-KIT

INCLUDES:

- (2) 482A4U plates
- (2) 480-4SBB surface mounting boxes
- (2) 400W1-433 transmitters
- (1) 400RC433 receivers



482R-KIT

INCLUDES:

- (2) 482A4RU plates
- (2) 480-4RSB surface mounting boxes
- (2) 400W1-433 transmitters
- (1) 400RC433 receivers



482S-CBCKIT

INCLUDES:

- (4) 482A4U plates
- (4) 480-4SBB surface mounting boxes
- (4) 400W1-433 transmitters
- (1) 400RC433 receivers

PUSH PLATES AND PANELS



482A4VWPU



482A4VPU

480V Series Vestibule Push Plates



Vestibule push plates feature two separate face plate switches that will allow for independent activation of two automatic doors.

480AA Series Push Panels



SDC's push panels allow for activation from any approach and height level. Pressing any part of the touch panel columns will activate the device creating seamless operation for users in ADA applications.

FEATURES AND BENEFITS

- Entire panel surface activates switch
- Naturally directs movement toward central activation column
- Sleek architectural profile
- No square edges to snag
- Wide sloping sides deflect impact from wheeled carts and conveyances
- Impact and vandal resistant design inhibits prying and tampering
- Wireless or hardwired
- Weather resistant



BOLLARDS

SDC's line of bollard posts are a practical alternative to wall mounted access controls or switches for entry doors. They combine visibility with convenience to meet or exceed accessibility and building code requirements throughout North America.

A choice of surface mount or in-ground installation models and a variety of push plate and panel switch options are offered. SDC's bollard posts are built with quality materials and attention to detail for durability in high traffic areas and harsh weather conditions.



FEATURES AND BENEFITS

- 6" square with 1/8" walls
- Black HDPE mortised removable cap
- Secure transmitter mount
- Standard prep located 36" from finished floor
- Choice of prep sizes

BP Series Square Bollard Posts



Alternative to wall mounted access control or switches for entry doors. Bollard posts provide visibility and meet accessibility guidelines. Straightforward, practical solution for surface mount or in-ground installation.

Push plates and panels ordered separately.

CBC Series Square High-Low CBC Compliant Bollard Posts



Alternative to wall mounted access control or switches for entry doors. Bollard posts provide visibility and meet accessibility guidelines. SDC's CBC series offers a practical solution for surface mount and California Building Code (CBC) compliance.

Push plates included.



COMPONENT CONSIDERATIONS

Hands Free Door Solution™

Use SDC operators and wave-to-open switches to create your own touchless, hands free door solution with or without access control for flexible solution applications to meet fire & life safety or ADA compliance.*

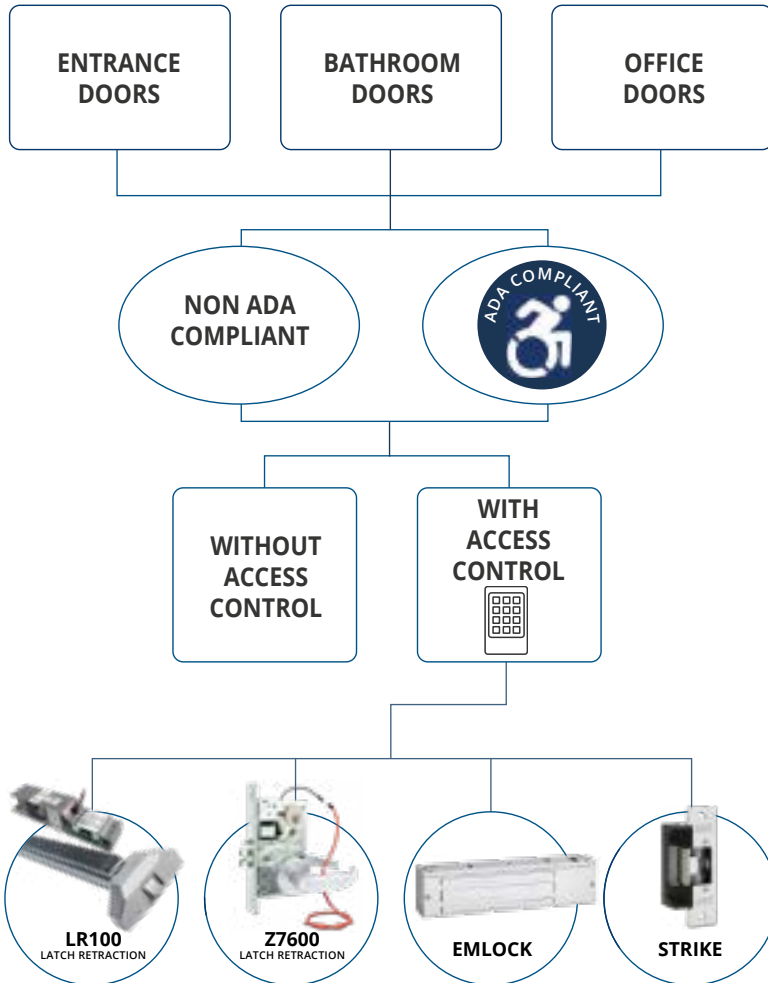

- 1 Qualify high touch, high traffic doors
- 2 Confirm if the door opening needs to meet requirements for ADA compliance
- 3 If the door opening does not require access and egress control, simply order:
 - (1) Auto EntryControl™
 - (2) 474 Touchless Switches
- 4 If access and egress control is required, identify the type of locking hardware needed for your door application before ordering

NO NEED FOR A SEPARATE POWER SUPPLY!

Auto EntryControl™ comes with its own 1Amp + Power Output and Sequencer

www.sdcsecurity.com/handsfree

* Even with national ANSI and ADA standards, building code enforcement relating to automatic doors and switch placement varies across the country. Consult your local Authority Having Jurisdiction (AHJ) for compliance requirements.

COMMON ADA COMPLIANT APPLICATION SOLUTIONS



Access & Egress Security Solutions Brochure

Common ADA compliant application solutions can be found on pages 14 – 18 and page 23.



www.sdcsecurity.com/Solutions-Brochure

Automated Magnetic Lock Access Control



Access & Egress Security Solutions Brochure Page 14

Automated Electric Strike Access Control



Access & Egress Security Solutions Brochure Page 15

COMMON ADA COMPLIANT APPLICATION SOLUTIONS

Automated Mortise Lock Access Control



Access & Egress Security Solutions Brochure Page 16

Hands Free ADA Compliant Access Control

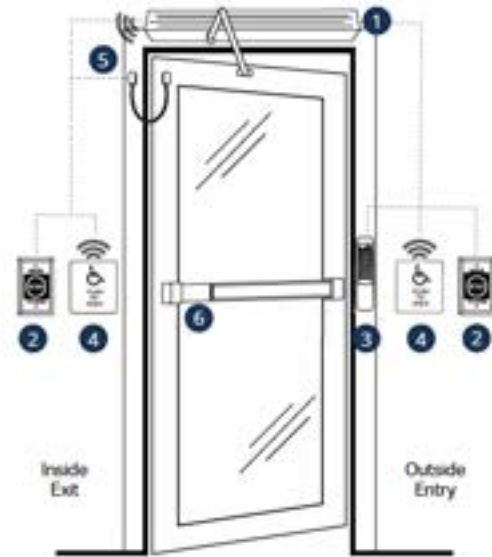

Access & Egress Security Solutions Brochure Page 17

Automated Entrance IP-Based Access Control



Access & Egress Security Solutions Brochure Page 18

Healthcare Market Automated ADA Compliant Openings



Access & Egress Security Solutions Brochure Page 23

ADA COMPLIANCE REFERENCES

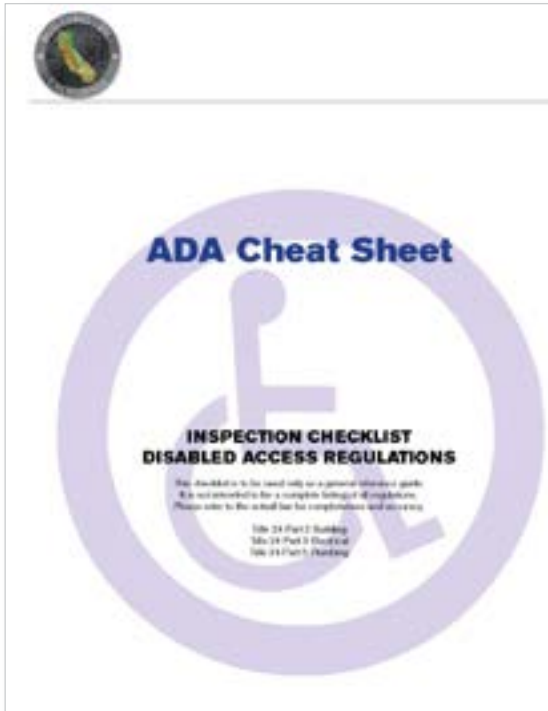

ADA Inspections Checklist



<http://bit.ly/3xIQZaN>

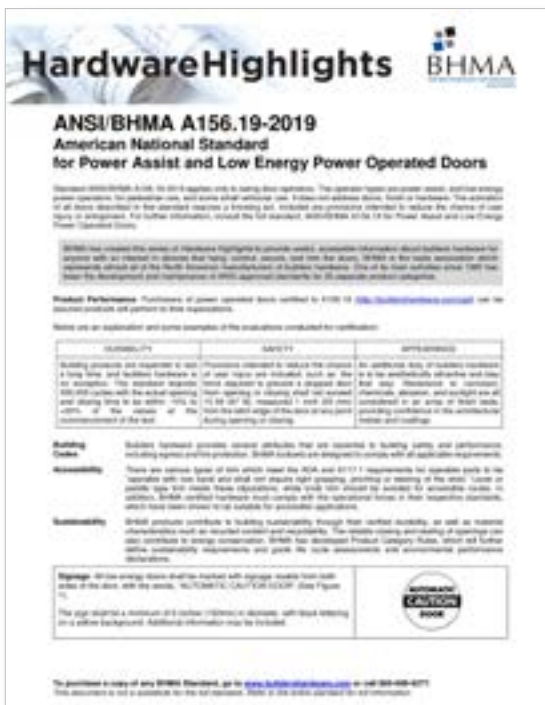

ANSI/BHMA A156.19-2019 Hardware Highlights



<http://bit.ly/3EaWOeY>

ADA COMPLIANCE REFERENCES



ANSI/BHMA A156.19-2019 Standard
for Power Assist and Low Energy Power
Operated Swinging Doors



<http://bit.ly/3k5iSAD>

COMPLETE COMPONENT CONSIDERATIONS

With a robust toolbox of over 35,000 SDC access & egress control components at your fingertips, you can assemble turnkey solutions to address both market-specific and application-specific requirements for almost any door opening imagined – while addressing a variety of factors, including:

- Level of Security
- Budget Restrictions
- Type of Door or Frame
- Life Safety Codes
- Aesthetics
- Retrofit or New Construction

BASIC COMPONENT CONSIDERATIONS FOR CONTROLLED DOOR SYSTEMS

- 1 LOCKING DEVICES
- 2 ACCESS CONTROLS
- 3 EGRESS CONTROLS
- 4 ADA CONTROLS
- 5 POWER TRANSFER DEVICES
- 6 POWER SUPPLY & DOOR CONTROLS
- 7 REMOTE CONTROLS & ANNUNCIATORS
- 8 ACCESSORIES & MISC

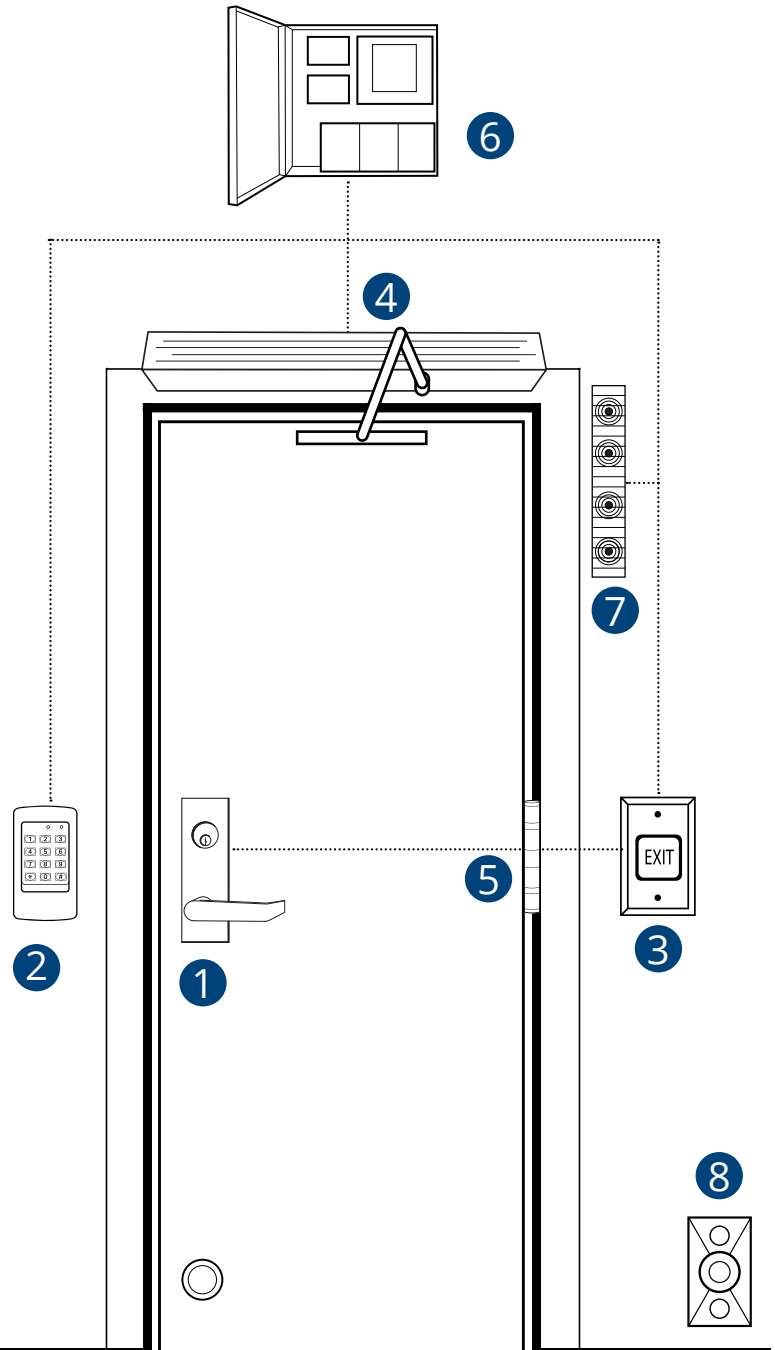

Components not to scale

1 LOCKING DEVICES

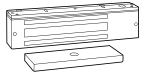

Electromagnetic Locks

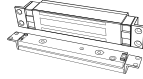

Electromagnetic Shear Locks

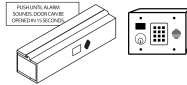

Delayed Egress Locks

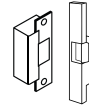

Electric Strikes



Electrified Locksets

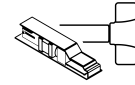

Exit Devices & Retrofit ELR Kits

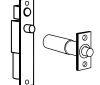

Electric Bolt Locks

2 ACCESS CONTROLS

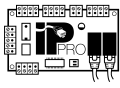

IP-Based Controllers

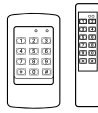

Keypads & Readers

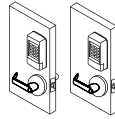

Standalone Locksets

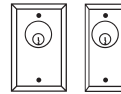

Key Switches

3 EGRESS CONTROLS

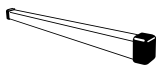

Egress Devices

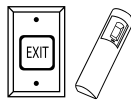

Exit Switches & Sensors



Emergency Door Releases

4 ADA CONTROLS

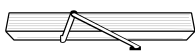

Low Energy Operators



Push Plates & Panels



Bollards

5 POWER TRANSFER DEVICES

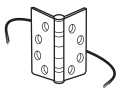

Hinges



Loops

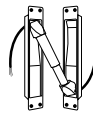

Mortise Transfer

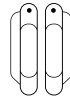

Wireless Transfer

6 POWER SUPPLY & DOOR CONTROLS

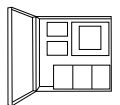

Power Controllers

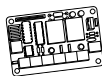

Door Controllers

7 REMOTE CONTROLS & ANNUNCIATORS



Remote Control Consoles

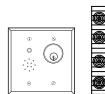

Door Prop Alarms & Annunciators

8 ACCESSORIES & MISC



Electromagnetic Door Holders



Door Position Monitoring



Latch & Deadbolt Monitoring Strikes



Wireless Transmitters & Receivers



Communicating Bathroom Switches

